



YJ-T5SA96W T5 Tube Specification

1. Features:

1. LED tube light
2. Input voltage: 90 to 260V AC
3. Net weight: 107.5g
4. Power consumption: 5.5W
5. Light sources: 96 pieces of 1210 SMDs
6. Current: 150mA
7. Emitting colors: warm white, pure white, cool white, red, green, blue and yellow
8. Luminous intensity: R(76-120LM), G(288-384LM), B(76-124LM), Y(76-120LM), W(480-576LM), WW(432-528LM), CW(480-624LM)
9. Length: 607.5*15*15mm
10. External the power supply
11. With 1/2 PC cover and 1/2 aluminum body

Picture:

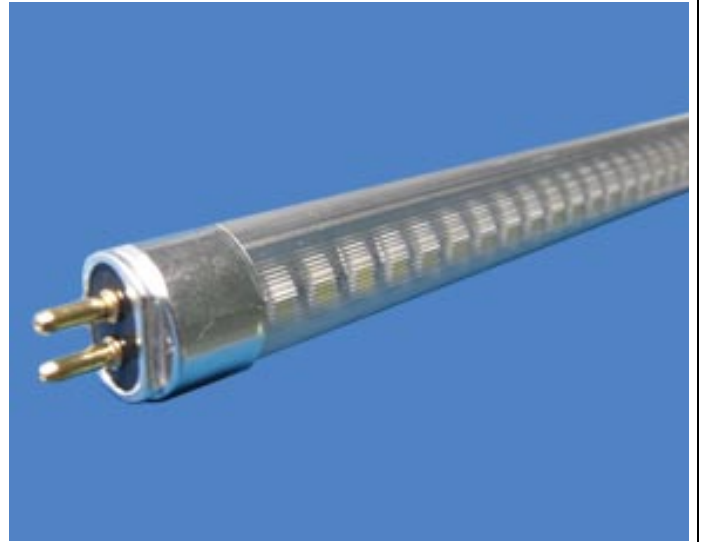

2, Using pictures:

Using sample photos:

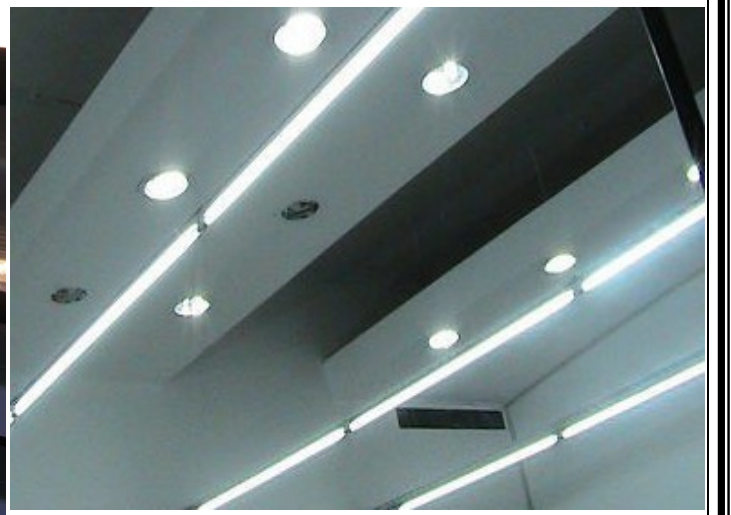





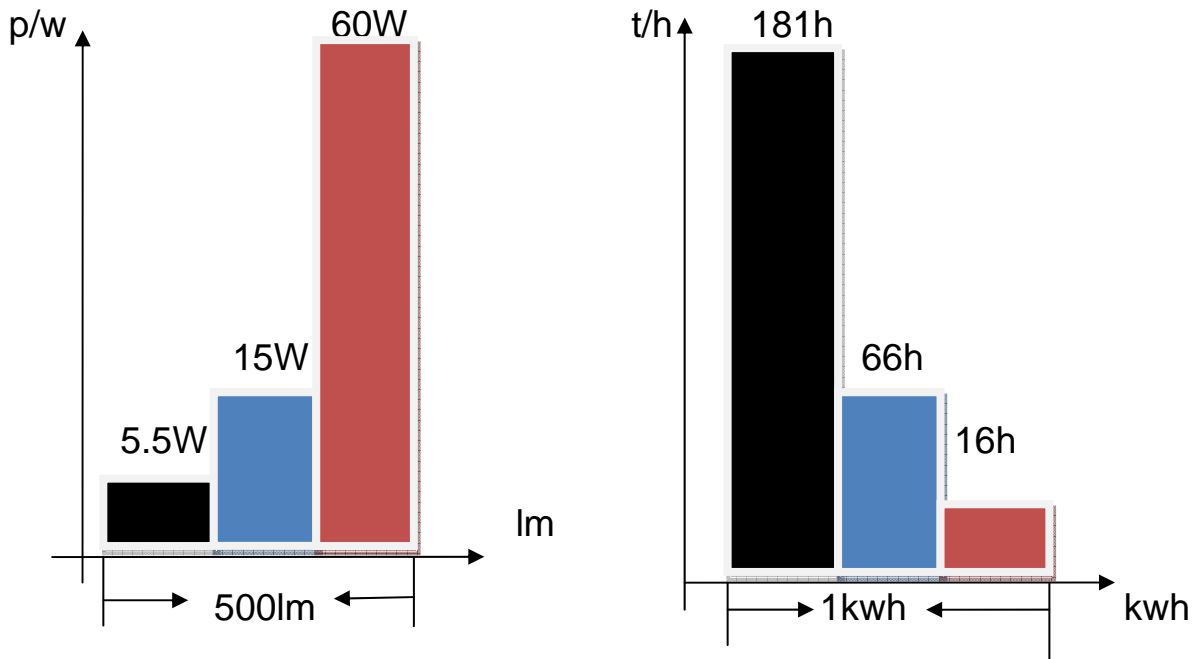

3. Traditional tube and LED lamp performance comparison:

Compare projects / Tube type	Incandescent (60W)	T5 Light bulbs (0.6M)	T5 LED bulbs (0.6M)
Working life	1000-2000H	3000-5000H	30000-50000H
Luminance	500LM	500LM	500LM
Power dissipation	60W	15W	5.5W

Schematic:



Explain:

-  → 0.6M T5 LED bulbs
-  → 0.6M T5 Light bulbs
-  → 60W Incandescent



5, Package Dimensions (mm):

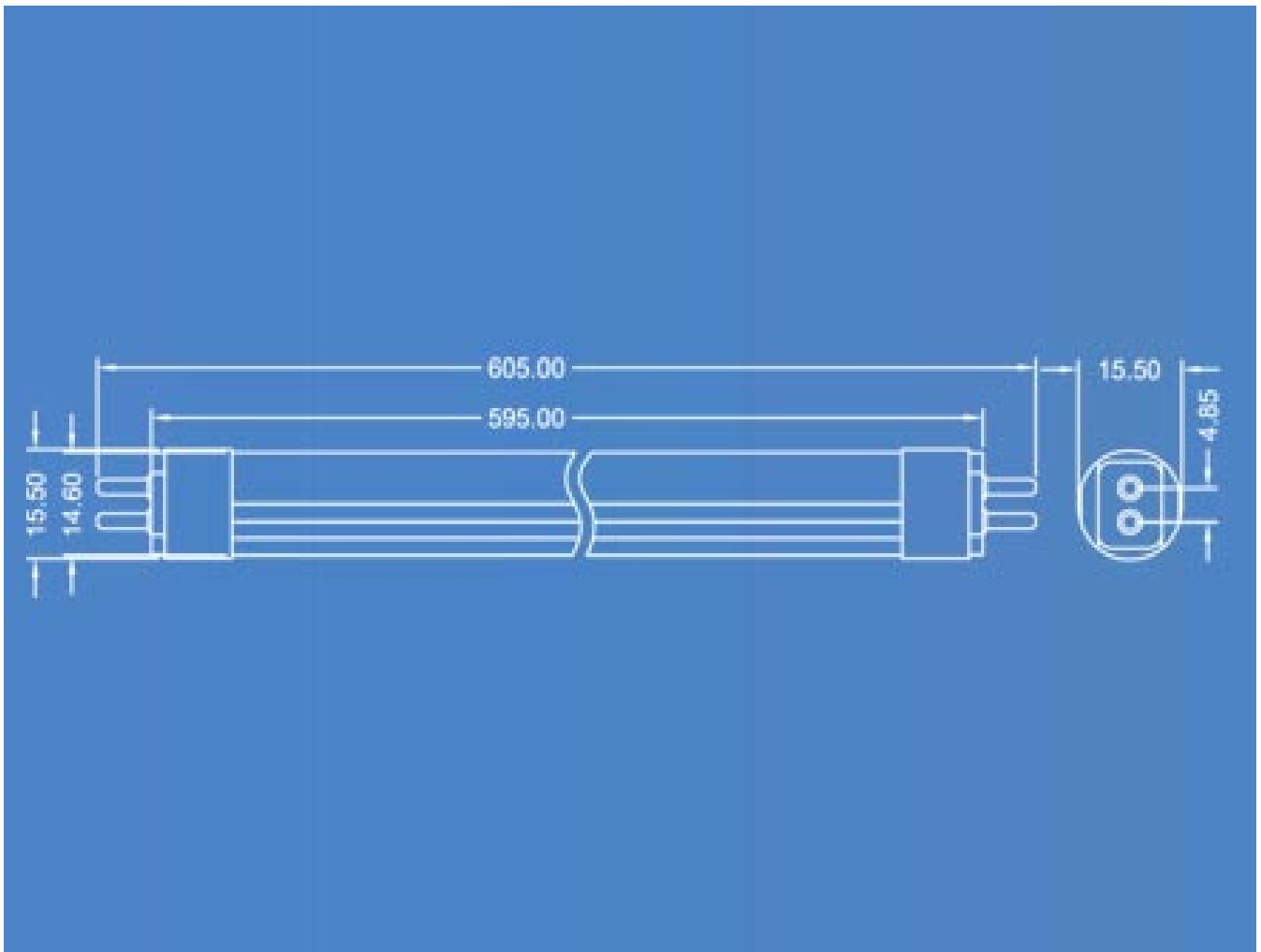

6, Absolute Maximum Rating at TA=25°C:

Part Number	Emitting Color	Input Voltage	Wattage	Color Temperature (k)		PMMA Cover	LED Quantity	Luminous Intensity(Lm)	
				MIN	MAX			MIN	MAX
YJ-T5SA96WW	Warm white	AC85~265V 50-60 HZ	5.5W	2700	4500	1/2 Stripe 1/2 Al	96pcs	432	528
YJ-T5SA96PW	Pure white		5.5W	5000	6500		96pcs	480	576
YJ-T5SA96CW	Cool white		5.5W	7000	12000		96pcs	480	624
YJ-T5SA96R	Red		5.5W	/	/		96pcs	76	120
YJ-T5SA96G	Green		5.5W	/	/		96pcs	288	384
YJ-T5SA96B	Blue		5.5W	/	/		96pcs	76	124
YJ-T5SA96Y	Yellow		5.5W	/	/		96pcs	76	120

**7. YJ-T5SA96W Characteristic:**

LIGHT EMITTING DIODE LAMPS			
Absolute maximum ratings		(Ta=25°C)	
	Symbol	Value	Unit
Forward current	If	20	mA
Reverse voltage	Vr	5	V
Power dissipation	Pd	72	mW
Operating temperature range	Top	-25~+80	°C
Storage temperature range	Top	-30~+80	°C
Peak pulsing current (1/8 duty f=1KHz)	If	125	mA

8. Electrical Draft: TA=25°C unless otherwise specified

Item	Explain	Conduction	Min.	Typ.	Max.	Unit.
Power dissipation		AC90~260V,96LED	5	5.5	6	W
Power factor		AC90~260V ,96LED	80		99	%
Power conversion efficiency		AC90~260V ,96LED	70	80	85	η
Center illumination		AC90~260V 96LED Height=2.5m		10		lux



9, Installtion:

Replace Method: (Note: It's an electronic start up tube light. The ballast must be taken out before using.
Direct replacement is not allowed.)

1. First remove the fluorescent tubes from the lamp stent.
2. Remove the ballast and the starter: if it's an electronic ballast, please remove it in accordance with the figure① and figure②. Figure① is the former circuit and figure② is the updated circuit; if there are the inductance ballast and the starter, please remove them in accordance with the figure③ and figure④. Figure③ is the former circuit and Figure④ is the updated circuit. Be sure to use this LED energy-saving lamp according to the circuit of Figure② or the circuit of Figure④.
3. Install the LED energy-saving lights at the original location of the fluorescent tubes.(Notice: The light must install downward)
4. Rotate the tube lightly and make illumination angle good.

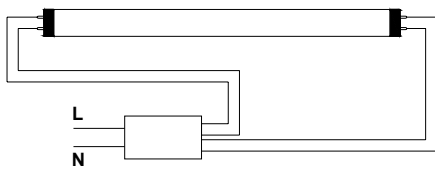

Electronic ballast

① Circuit of electronic fluorescent

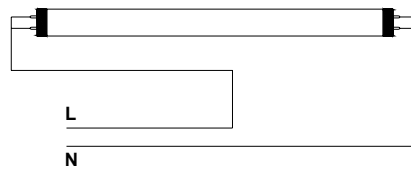

② Circuit of LED energy-saving lamp

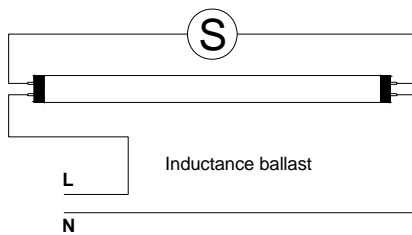

Inductance ballast

③ Circuit of inductance fluoescent

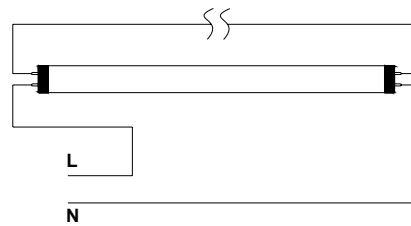

④ Circuit of LED energy-saving lamp

Or for easily install

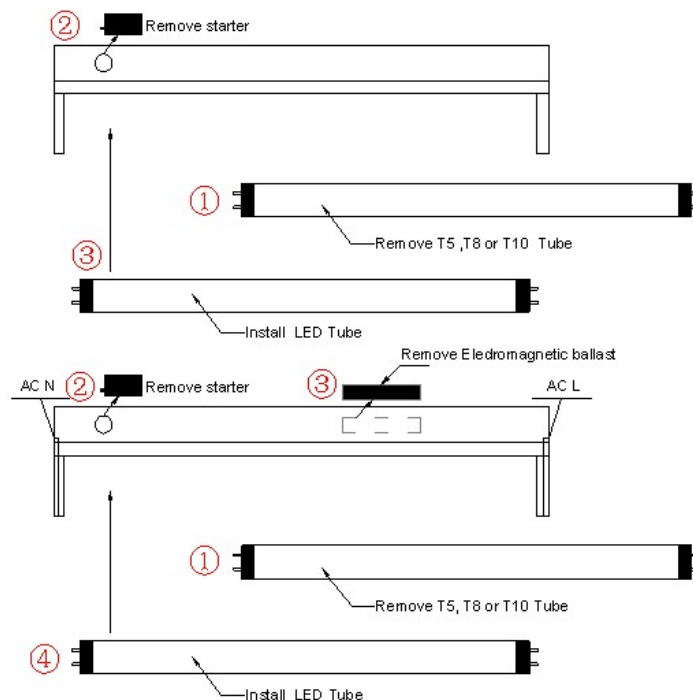



11. Package Information:

Net (g)	Into Box Size (cm)	Qty/Into BOX	Outside coat Size (cm)	Qty/ Outside coat	Total Weight (kg)
107.5	62*2*2	1	126*23*12	100	13

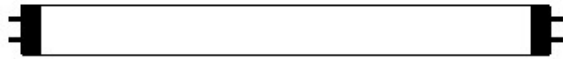

LED Tube Light

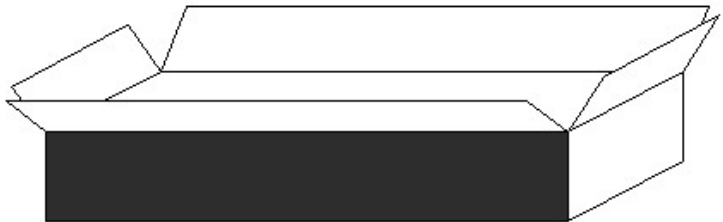
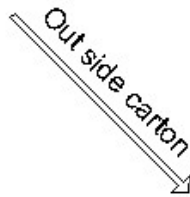
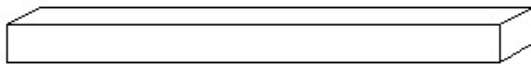

12. After-sales service:

All products have one year quality guarantee under right and normal using condition. Quality warranty is based on correct conservation, assemblage, use and maintenance. In case problem within promised time, "Aglare" will solve it by repair, substitute accessories or replace at your option. Upon exceeding the promised time, there will be material and maintenance fees to be paid.